

10" DUCT INLET

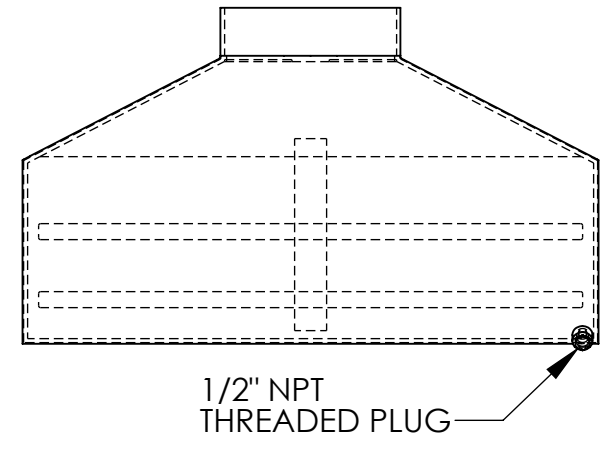
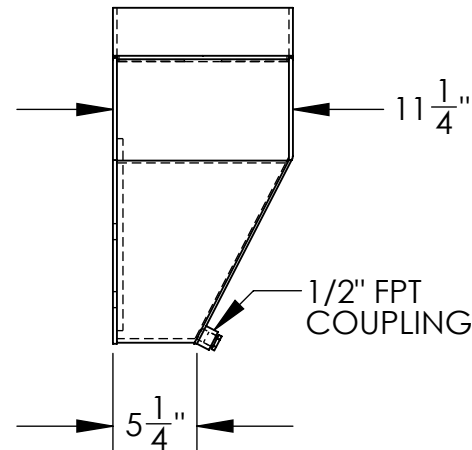
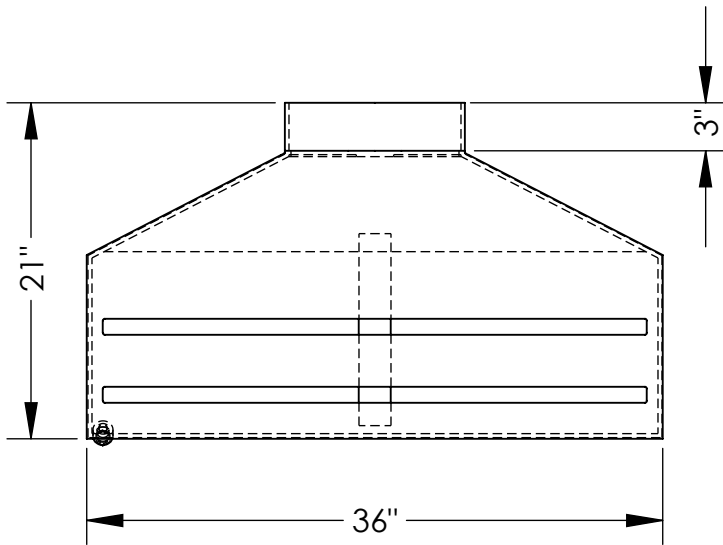
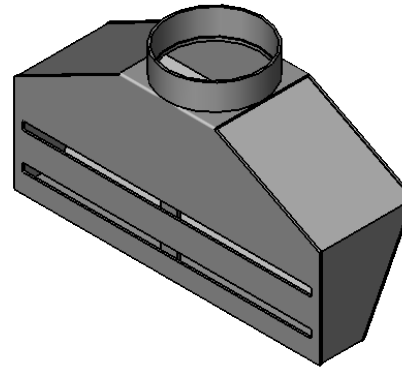
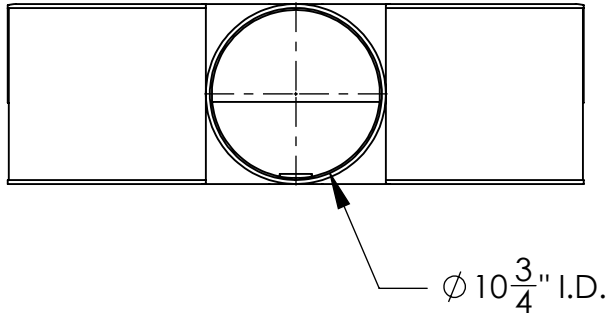

1/4" WALL

 **PLASTIC SUPPLY**
of PENNSYLVANIA
21 SOUTH LIMERICK RD. ROYERSFORD, PA 19468
(610) 326-5112 www.plasticsupply.net

MATERIAL: PVC GRAY

PVC INTAKE FUME HOOD, STYLE 1

PART #: **PVCHS136**